

2/24



AUSTRALIAN CUSTOMS SERVICE

# APPLICATION FOR A TARIFF CONCESSION ORDER (TCO)

'98 MAY 21 16:13

Please read the form carefully before completing.

- Section 269F of the *Customs Act 1901* requires a TCO application to be in an "approved form", contain such information as the form requires, and be signed in the manner indicated in the form. **THIS IS THE APPROVED FORM FOR THE PURPOSES OF THAT SECTION. EVERY QUESTION MUST BE ANSWERED.**
- Applicant's obligation - Section 269FA of the *Customs Act 1901* sets out the responsibility of an applicant for a TCO to establish to the satisfaction of the Chief Executive Officer (CEO), that on the basis of:
  - all information that the applicant has, or can be reasonably expected to have; and
  - all inquiries that the applicant has made, or can reasonably be expected to make; there are reasonable grounds for asserting that the application meets the core criteria.
- Failure to supply the information required by this form will result in rejection of the application and consequential loss of operative date.
- Where there is insufficient space, answers may be provided by attachment, which should clearly identify the question to which the attachment relates.
- The identity of the applicant and of the importer for whom the applicant is acting will be published in the Gazette.
- An application will be date stamped on the day it is first received in Canberra by an officer of Customs in accordance with the instructions specified at the end of this form. Any resultant TCO comes into force **ON THAT DAY.**
- All information about inquiries into the production of substitutable goods must relate to the date this application is lodged with Customs.
- Further information on the Tariff Concession System is available in Part XVA of the *Customs Act 1901*, the foreword to the Schedule of Concessional Instruments (SCI), the administrative guidelines in Volume 13 of the Australian Customs Service (ACS) Manual, or by phoning (06) 276 6668.
- Customs may require an applicant to substantiate with documentary evidence any information provided on the application form.
- TCOs are available for use by any importer and are published in the SCI and in TAPIN. Before lodging a TCO application, check to ensure an existing TCO does not already cover the goods.

### APPLICANT DETAILS

Applicant's Name <b>IMI NORGREN PTY LTD</b>		A.C.N. <b>004 384 249</b>
Postal address <b>P. O. BOX 457 KNOXFIELD VIC 3178</b>		
Applicant's Reference <b>NOR/MOS-VAC/PUMP</b>	Owner Code (if applicable) <b>0905410A</b>	
Company Contact <small>S47F</small>	Position Held <small>S47F</small>	
Phone Number <small>S47F</small>	Facsimile Number <b>03 9 213 0898</b>	

### IMPORTER DETAILS

If you are not proposing to make use of the TCO to import the goods to which the application relates into Australia on your own behalf - the identity of the importer for whom you are acting must be provided (paragraph 269F(1)(c) of the *Customs Act 1901*).

Name of importer (if same as Applicant, state "As above")		
A.C.N.	Owner Code	Importer's Reference
Postal address		
Company Contact	Phone Number	Facsimile Number

Released by Department of Home Affairs under the Freedom of Information Act 1982

3/24

AGENT/BROKER DETAILS (if applicable)

Name of Agent M + D JONES CUSTOMS PTY LTD		
A.C.N. 006 753 439	Agent's Reference MDJ/WOR - VAC/PUMPS	
Postal address P. O. Box 141 NORTH MELBOURNE Vic 3051		
Agency Contact [REDACTED]	Phone Number 03 9 329 5399	Facsimile Number 03 9 328 4666

DESCRIPTION OF GOODS

1 Description of the goods

This description will be used as the description of goods in a TCO, and, in accordance with section 2695J of the Customs Act 1901, must NOT:

- describe the goods in terms other than generic terms; or
- describe the goods in terms of their intended end use; or
- describe goods declared by the regulations to be goods to which a TCO should not extend.

Goods are taken NOT to be described in generic terms if their description, either directly or by implication, indicates that they are goods of a particular brand or model, or that a particular part number applies to the goods.

Guidance for the drafting of TCO descriptions is contained in Volume 13, Appendix H, of the ACS Manual.

PUMPS, ROTARY VACUUM OIL FREE, HAVING ALL OF THE FOLLOWING

A) VACUUM RANGE FROM 1" HG TO 29.6" HG

B) MOTOR DRIVEN

These appear to be imperial, if so metric required.

2 Attach technical, illustrative descriptive material and/or sample to enable a full and accurate identification of the goods the subject of the application.

3 Tariff Classification (to 8 figure subheading level)  General Duty rate  %

If a Tariff Advice for the goods has been sought or obtained, please provide TA No. or attach a copy.

4 Describe ALL uses (including design uses) to which the goods can be put.

VACCUUM PUMPS FOR AIR AND GAS

Released by Department of Home Affairs under the Freedom of Information Act 1982

4/24

**SUBSTITUTABLE GOODS**

- (1) Local Manufacturers' goods are substitutable when they are put, or are capable of being put, to a use that corresponds with a use (including a design use) to which the goods the subject of the application can be put (subsection 269B(1) of the Customs Act 1901). Even if not identical, locally made goods may be substitutable goods.
  - (2) In determining whether the uses of Australian produced goods correspond with the uses of the goods the subject of the application - it is irrelevant whether or not the goods compete with each other in any market.
  - (3) Applications will be rejected if they fail to provide sufficient information as to inquiries made by the applicant to establish that there are reasonable grounds for believing that no substitutable goods are produced in Australia.
- 5 Provide details of the nature of ALL inquiries you have undertaken in order to establish that substitutable goods are not produced in Australia in the ordinary course of business and the results of those inquiries.

THIS APPLICATION IS BEING LODGED BECAUSE TC 9407672 WAS REVOKED BY L.M. BLOVAC, AND OUR CLIENT NORGREN STRONGLY BELIEVED THAT L.M. BLOVAC DO NOT MAKE SUBSTITUTABLE GOODS. IN VIEW OF THIS WE HAVE APPROACHED L.M. BLOVAC AND SEVERAL OTHER LOCAL MANUFACTURER AS LISTED IN KOMPASS DIRECTORY UNDER PUMPS FOR AIR AND GAS, VACUUM PUMPS 40 25 00.

- 6 Provide any additional information in support of discharging your responsibility to establish that there are reasonable grounds for asserting that there are no substitutable goods produced in Australia in the ordinary course of business.

PLEASE FIND COPY OF MY FAXES, ALONG WITH THE REPLIES WE HAVE RECEIVED SO FAR. PLEASE NOTE THESE FAXES WERE SENT OUT ON THE 7/5/98 AND MORE THAN 10 DAYS HAVE PASSED

5/24

**PRESCRIBED ORGANISATIONS**

7 Have you made inquiries of a prescribed organisation to obtain advice about whether there are producers in Australia of substitutable goods?

YES  NO If YES attach a copy of advice received.

Note that under subsection 269M(6) of the Customs Act 1901, the CEO may, despite section 16 of the Customs Administration Act 1985, give a copy of all, or of a part, of the application to a prescribed organisation.

FOR USE OF  
PRESCRIBED  
ORGANISATION ONLY

▶ Prescribed Organisation's Reference **KOMPASS AUSTRALIA DIRECTORY**

▶ Prescribed Organisation's Advice:  
**COPIES OF RELEVANT PAGES INCLUDED**

8 Provide any additional information in support of your application.

I, <sup>S47F</sup> [Redacted] Position Held <sup>S47F</sup> [Redacted]

Company (if applicable)  
**M + D JONES CUSTOMS PTY LTD**

declare that:  
1 To the best of my knowledge and belief the information contained in this submission is correct;  
2 I have the authority to act on behalf of the company/applicant.  
Signature of Applicant/Agent/Broker <sup>S47F</sup> [Redacted] Date **21/5/98**

NOTE: SECTION 234 OF THE CUSTOMS ACT 1901 PROVIDES THAT IT IS AN OFFENCE TO MAKE A STATEMENT TO AN OFFICER THAT IS FALSE OR MISLEADING IN A MATERIAL PARTICULAR.

WHEN THIS FORM HAS BEEN COMPLETED LODGE IT WITH CUSTOMS BY:

- posting it by prepaid post to the National Manager, Industry Branch, Australian Customs Service, Customs House, 5 Constitution Avenue, CANBERRA ACT 2601; or
- leaving it in the box provided in the foyer of Customs House, Canberra; or
- sending it by facsimile to (06) 275 6376.

Released by Department of Home Affairs under the Freedom of Information Act 1982







**M. & D. JONES CUSTOMS PTY. LTD.**  
 CUSTOMS & FORWARDING BROKERS  
 ACN 008 753 439  
**TOMAX CONTAINER LINE AUSTRALIA PTY LTD.**  
 ACN 007 121 191

#/2  
 TEL 8/24

1ST FLOOR, 558 QUEENSBERRY STREET  
 NORTH MELBOURNE, VICTORIA 3051  
 PO BOX 141, NORTH MELBOURNE VIC. 3051

TELEPHONE: (03) 9329 5399

FAX: (03) 9328 4666

FAXED

No. OF PAGES INCLUDING THIS ONE: Two (2) PAGE

ATTENTION S47F	COMPANY / LOCATION BLOVAC - Q'LD.	FAX No. 07 55916934	
SENDER S47F	BUSINESS UNIT / LOCATION TARIFF CONSULTANT M + D JONES CUSTOMS P/L	DATE 7/5/98	TIME

WE ARE FAXING YOUR COMPANY TO INFORM YOU OF OUR INTENTIONS TO LODGE THE BELOW WORDED TARIFF CONCESSION APPLICATION

PLEASE NOTE THIS APPLICATION IS TO REPLACE A TC 9407672 WHICH WAS WITHDRAWN SOMETIME AGO BY YOURSELVES.

REASON FOR THIS IS THAT WE BELIEVE YOU ONLY MANUFACTURE VACUUM GENERATORS/PUMPS THAT ARE AIR OPERATED, AND NOT VACUUM PUMPS, THAT HAVE MOTOR DRIVEN UNITS FOR VACUUM PUMPS.

PLEASE CONFIRM BY RETURN FAX IF YOU HAVE NO OBJECTION, OR IF YOU REQUIRE MORE INFORMATION

WORDING IS :-

8414 1000 PUMPS, ROTARY VACUUM, OIL FREE, HAVING THE FOLLOWING

A) VACUUM RANGE FROM 1" HG TO 29.6" HG

THANKS + REGARD

S47F

M + D JONES CUSTOMS PTY LTD  
TARIFF CONSULTANT

ORIGINAL

Released by Department of Home Affairs under the Freedom of Information Act 1982

G08:7705 REV 0



P O BOX 1395, SOUTHPORT  
QUEENSLAND 4215,  
AUSTRALIA  
PHONE: 07 - 5591 3109  
FAX: 07 - 5591 6934  
INTERNATIONAL  
PHONE: +61 7 5591 3109  
FAX: +61 7 5591 6934

9/  
24

**TELEFAX MESSAGE**

**COMPANY:** M & D JONES CUSTOMS PTY LTD  
**LOCATION:** MELBOURNE  
**ATTENTION:** S47F  
**REGARDING:** TARIFF 8414.1000

**DATE:** 19-May-98  
**PAGES:** 1 of 1

Dear S47F

Firstly my apologies for the delay in responding to your fax of 7/5/98.

We have no objections to your lodging the tariff concession application provided that the words **motor driven** are included in the wording as follows:-

8414.1000 Pumps, rotary vacuum, motor driven, oil free, having the following  
(a) Vacuum range from 1"Hg to 29.6"Hg

Regards



REPLY

Released by Department of Home Affairs under the Freedom of Information Act 1982



2/2 (9)  
10/24

# Motor Mounted Rotary Vane .6, 1.1, and 1.5 cfm

## Oilless 0531, 1031, 1531

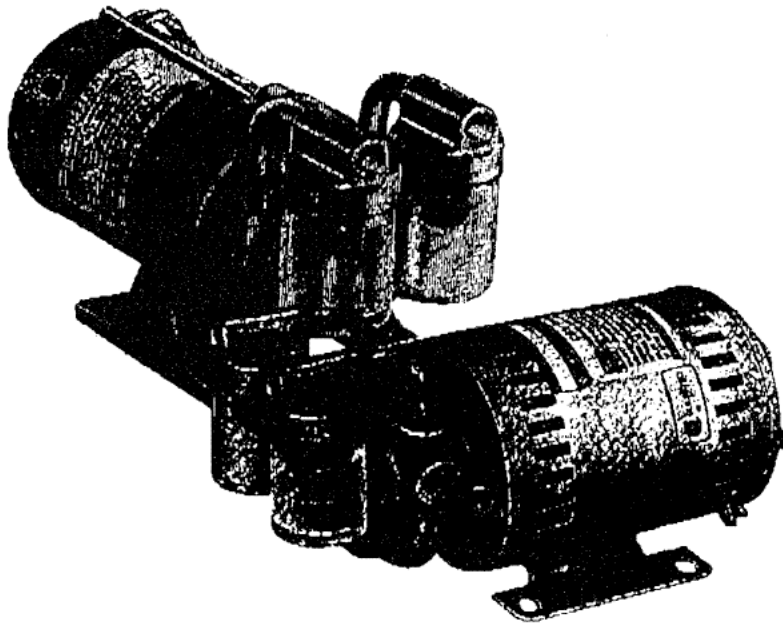

**MODEL 0531 SERIES**  
20" MAX. VAC., .80 CFM OPEN FLOW

**MODEL 1031 SERIES**  
20" MAX. VAC., 1.10 CFM OPEN FLOW

**MODEL 1531 SERIES**  
20" MAX. VAC., 1.50 CFM OPEN FLOW

### PRODUCT FEATURES

- Oilless operation
- Motor mounted
- Rugged construction/low maintenance
- Essentially pulse-free service

### INCLUDES (ALL MODELS)

- Muffler
- Filter
- Thermotector (on AC models only)

### RECOMMENDED ACCESSORIES

- Vacuum relief valve AA204
- Vacuum gauge AA641
- Repair kit K259 (0531), K219 (1031), K219 (1531)

### COMMON MOTOR OPTIONS AVAILABLE

- 115V, 60/50 Hz, single phase
- 230V, 60/50 Hz, single phase
- 12V DC
- 24V BLDC

Various brand name motors are used on any model

### Important Notice:

Pictorial and dimensional data is subject to change without notice.

### Product Dimensions Metric (mm) U.S. Imperial (Inches)

Model	A	B	C	D	E	F	G	H	I	J	K	L
0531	62	223	76	33	89	67	22	103	111	-	-	-
0531	2.44	8.78	3.00	1.28	3.50	2.62	.88	4.06	4.37	-	-	-
1031	62	229	76	33	89	67	22	118	124	-	-	-
1031	2.44	9.00	3.00	1.28	3.50	2.62	.88	4.57	4.88	-	-	-
1531	62	228	72	39	-	44	-	113	121	86	106	53
1531	2.44	8.97	2.82	1.53	-	1.75	-	4.45	4.76	3.38	4.19	2.07

Dimensions for reference only.

Models 0531, 1031

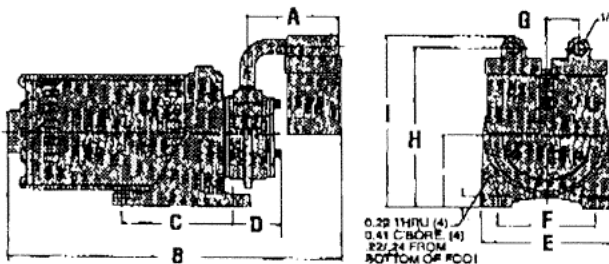

Model 1531

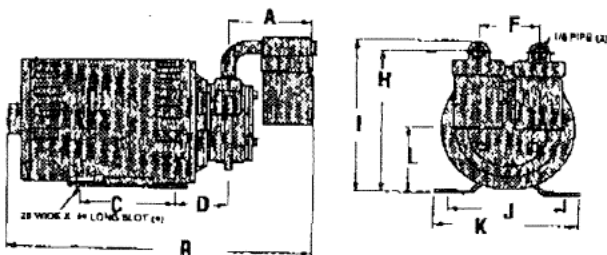

Released by Department of Home Affairs under the Freedom of Information Act 1982



**M. & D. JONES CUSTOMS PTY. LTD.**  
CUSTOMS & FORWARDING BROKERS  
**TOMAX CONTAINER LINE AUSTRALIA PTY LTD.**

1ST FLOOR, 559 QUEENSBERRY STREET  
NORTH MELBOURNE, VICTORIA 3051  
PO BOX 141, NORTH MELBOURNE VIC. 3051

TELEPHONE: (03) 9329 5399

FAX: (03) 9328 4866



ACN 006 783 439  
ACN 007 131 191  
**FAKED**

11/24/18  
+1/2

No. OF PAGES INCLUDING THIS ONE: **TWO (2) PAGES**

<p>ATTENTION</p> <p>S47F [REDACTED]</p>	<p>COMPANY / LOCATION</p> <p>BUDGE ELLIS STAFF CO-OP</p>	<p>FAX No.</p> <p>0296485224</p>	
<p>SENDER</p> <p>S47F [REDACTED]</p>	<p>BUSINESS UNIT / LOCATION</p> <p>TARIFF CONSULTANT M + D JONES CUSTOMS P/L</p>	<p>DATE</p> <p>8/5/98</p>	<p>TIME</p>

WE ARE FAXING YOUR COMPANY TO INFORM YOU OF OUR INTENTIONS TO LODGE THE BELOW WORDED CONCESSION APPLICATION

PLEASE NOTE I HAVE INCLUDED AN INFORMATION SHEET FOR YOUR PERUSAL.

PLEASE EITHER REPLY BY FAX / LETTER YOUR ACCEPTANCE AND NO OBJECTION TO THIS APPLICATION, OR IF YOU REQUIRE MORE INFORMATION OR CHANGES TO THE WORDING PLEASE RING.

WORDING IS :-

84141000

PUMPS, ROTARY VACUUM, OIL FREE, HAVING THE FOLLOWING  
A) VACUUM RANGE FROM 1" HG TO 29.6" HG.

THANKS + REGARDS

S47F [REDACTED]

M + D JONES CUSTOMS PTY LTD  
TARIFF CONSULTANT.

ORIGINAL

12/24 (17)



**BUDGE-ELLIS STAFF CO-OPERATIVE LTD**

A.R.B.N. 052 958 498

INCORPORATED IN NSW

CONTRACTOR LICENCE No. 22877C

106 Wetherill Street, Silverwater, N.S.W. 2128, Australia

Phone: (02) 9748 0313

ALL CORRESPONDENCE TO: P.O. BOX 6600 SILVERWATER 2128

Fax: (02) 9648 5224

Ref: L80514B

May 14, 1998

M & D Jones Customs Pty Ltd  
PO Box 141  
North Melbourne VIC 3051

Attention <sup>S47F</sup> [Redacted]

**Re: Tariff Concession Application  
84141000 ~ Pumps Rotary Vacuum Oil Free**

Dear Sir

We wish to advise that our company has no objection to the proposed application for a tariff concession, for the rotary vacuum pumps as specified in your fax dated May 8, 1998

Yours faithfully  
**Budge-Ellis Staff Co-operative Ltd**

<sup>S47F</sup> [Redacted Signature Block]

Released by Department of Home Affairs  
under the Freedom of Information Act 1982

REPLY



**M. & D. JONES CUSTOMS PTY. LTD.**  
CUSTOMS & FORWARDING BROKERS  
ACN 006 753 439  
**TOMAX CONTAINER LINE AUSTRALIA PTY LTD.**  
ACN 007 121 181



1ST FLOOR, 559 QUEENSBERRY STREET  
NORTH MELBOURNE, VICTORIA 3051  
PO BOX 141, NORTH MELBOURNE VIC. 3051  
TELEPHONE: (03) 9329 5399

FAX: (03) 9328 4666

13/24 (16)

Handwritten 'FAXED' stamp and initials 'H/2'

No. OF PAGES INCLUDING THIS ONE: **TWO (2) PAGES**

ATTENTION S47F	COMPANY / LOCATION S.F.F. MINERALS (FULLER F.L SAUDI PACIFIC P/L)	FAX No. 0294363886	
SENDER S47F	BUSINESS UNIT / LOCATION TARIFF CONSULTANT M + D JONES CUSTOMS P/L	DATE 8/5/98	TIME

WE ARE FAXING YOUR COMPANY TO INFORM YOU OF OUR INTENTIONS TO LODGE THE BELOW WORDING CONCESSION APPLICATION

PLEASE NOTE I HAVE INCLUDED AN INFORMATION SHEET FOR YOUR PERUSAL.

PLEASE EITHER REPLY BY FAX / LETTER YOUR ACCEPTANCE, AND NO OBJECTION TO THIS APPLICATION, OR IF YOU REQUIRE MORE INFORMATION OR CHANGES TO THE WORDING PLEASE RING.

WORDING IS :-

84141000  
PUMPS, ROTARY VACUUM, OIL FREE, HAVING THE FOLLOWING  
A) VACUUM RANGE FROM 1" HG TO 29.6" HG.

THANKS + REGARDS

S47F [Redacted signature]

M + D JONES CUSTOMS PTY LTD  
TARIFF CONSULTANT.

Released by Department of Home Affairs  
under the Freedom of Information Act 1982

14/24



**M. & D. JONES CUSTOMS PTY. LTD.**  
CUSTOMS & FORWARDING BROKERS  
ACN 008 753 439  
**TOMAX CONTAINER LINE AUSTRALIA PTY LTD.**  
ACN 007 121 191



1ST FLOOR, 559 QUEENSBERRY STREET  
NORTH MELBOURNE, VICTORIA 3051  
PO BOX 141, NORTH MELBOURNE VIC. 3051  
TELEPHONE: (03) 9329 5399 FAX: (03) 9328 4665

RECEIVED  
H/2

No. OF PAGES INCLUDING THIS ONE: Two (2) PAGES

ATTENTION S47F	COMPANY / LOCATION JAVAC P/L	FAX No. 9763 2756	
SENDER S47F	BUSINESS UNIT / LOCATION TARIFF CONSULTANT M + D JONES CUSTOMS P/L	DATE 8/5/98	TIME

WE ARE FAXING YOUR COMPANY TO INFORM YOU OF OUR INTENTIONS TO LODGE THE BELOW WORDED CONCESSION APPLICATION

PLEASE NOTE I HAVE INCLUDED AN INFORMATION SHEET FOR YOUR PERUSAL.

PLEASE EITHER REPLY BY FAX / LETTER YOUR ACCEPTANCE AND NO OBJECTION TO THIS APPLICATION, OR IF YOU REQUIRE MORE INFORMATION OR CHANGES TO THE WORDING PLEASE RING

WORDING IS :-

84141000  
PUMPS, ROTARY VACUUM, OIL FREE HAVING THE FOLLOWING  
A) VACUUM RANGE FROM 1" HG TO 29.6" HG.

THANKS + REGARDS

S47F

M + D JONES CUSTOMS PTY LTD  
TARIFF CONSULTANT.

Released by Department of Home Affairs  
under the Freedom of Information Act 1982

15/24 (14)



**M. & D. JONES CUSTOMS PTY. LTD.**  
CUSTOMS & FORWARDING BROKERS  
**TOMAX CONTAINER LINE AUSTRALIA PTY LTD.**

ACN 006 763 439  
ACN 007 121 191



1ST FLOOR, 559 QUEENSBERRY STREET  
NORTH MELBOURNE, VICTORIA 3051  
PO BOX 141, NORTH MELBOURNE VIC. 3051

TELEPHONE: (03) 9329 5399

FAX: (03) 9328 4666

*Handwritten:* FAXED

*Handwritten:* 1/2

No. OF PAGES INCLUDING THIS ONE: *Handwritten:* Two (2) PAGES

ATTENTION S47F	COMPANY / LOCATION ROEHLEN IND. P/L	FAX No. 0295423317	
SENDER S47F	BUSINESS UNIT / LOCATION TARIFF CONSULTANT M + D JONES CUSTOMS P/L	DATE 8/5/98	TIME

WE ARE FAXING YOUR COMPANY TO INFORM YOU OF OUR INTENTIONS TO LODGE THE BELOW WORDED CONCESSION APPLICATION

PLEASE NOTE I HAVE INCLUDED AN INFORMATION SHEET FOR YOUR PERUSAL.

PLEASE EITHER REPLY BY FAX / LETTER YOUR ACCEPTANCE, AND NO OBJECTION TO THIS APPLICATION, OR IF YOU REQUIRE MORE INFORMATION OR CHANGES TO THE WORDING PLEASE RING.

WORDING IS :-

84141000  
PUMPS, ROTARY VACUUM, OIL FREE, HAVING THE FOLLOWING  
A) VACUUM RANGE FROM 1" HG. TO 29.6" HG.

THANKS + REGARDS

S47F [Redacted Signature]

M + D JONES CUSTOMS PTY LTD  
TARIFF CONSULTANT.

Released by Department of Home Affairs  
under the Freedom of Information Act 1982

20257730 REV 0

16/24



**M. & D. JONES CUSTOMS PTY. LTD.**  
CUSTOMS & FORWARDING BROKERS  
**TOMAX CONTAINER LINE AUSTRALIA PTY LTD.**

ACN 008 753 439  
ACN 007 121 191



1ST FLOOR, 559 QUEENSBERRY STREET  
NORTH MELBOURNE, VICTORIA 3051  
PO BOX 141, NORTH MELBOURNE VIC. 3051

TELEPHONE: (03) 9329 5399

FAX: (03) 9328 4666

Handwritten: *FAKING* *1/2*

No. OF PAGES INCLUDING THIS ONE: **TWO(2) PAGES**

ATTENTION S47F	COMPANY / LOCATION SULZER AUSTRALIA	FAX No. 0294763723	
SENDER S47F	BUSINESS UNIT / LOCATION TARIFF CONSULTANT M + D JONES CUSTOMS P/L	DATE 8/5/98	TIME

WE ARE FAXING YOUR COMPANY TO INFORM YOU OF OUR INTENTIONS TO LODGE THE BELOW WORDED CONCESSION APPLICATION

PLEASE NOTE I HAVE INCLUDED AN INFORMATION SHEET FOR YOUR PERUSAL.

PLEASE EITHER REPLY BY FAX / LETTER YOUR ACCEPTANCE AND NO OBJECTION TO THIS APPLICATION, OR IF YOU REQUIRE MORE INFORMATION OR CHANGES TO THE WORDING PLEASE RING.

WORDING IS :-

84141000

PUMPS, ROTARY VACUUM, OIL FREE HAVING THE FOLLOWING  
A) VACUUM RANGE FROM 1" HG TO 29.6" HG.

THANKS + REGARDS

S47F [Redacted Signature]

M + D JONES CUSTOMS PTY LTD  
TARIFF CONSULTANT.

Released by Department of Home Affairs  
under the Freedom of Information Act 1982

ORIGINAL

08 MAY '98 11:46 FROM SULZER SYDNEY  
14.05. '98 10:23:01

TO 0393284666

P.01/01

17/24 (12)



**M. & D. JONES CUSTOMS PTY. LTD.**  
CUSTOMS & FORWARDING BROKERS  
**TOMAX CONTAINER LINE AUSTRALIA PTY LTD.**



+1/2

181 FLOOR, 559 QUEENSBERRY STREET  
NORTH MELBOURNE, VICTORIA 3051  
PO BOX 141, NORTH MELBOURNE VIC. 3051

TELEPHONE: (03) 9328 5399

FAX: (03) 9328 4888

No. OF PAGES INCLUDING THIS ONE: **TWO (2) PAGES**

ATTENTION [REDACTED]	COMPANY / LOCATION SULZER AUSTRALIA	FAX No. 0294763723	
SENDER [REDACTED]	BUSINESS UNIT / LOCATION TARIFF CONSULTANT M+D JONES CUSTOMS P/L	DATE 8/5/98	TIME

TO

WE ARE FAXING YOUR COMPANY TO INFORM YOU OF OUR INTENTIONS TO LODGE THE BELOW WORDED CONCESSION APPLICATION

PLEASE NOTE I HAVE INCLUDED AN INFORMATION SHEET FOR YOUR PERUSAL.

PLEASE EITHER REPLY BY FAX / LETTER YOUR ACCEPTANCE AND NO OBJECTION TO THIS APPLICATION, OR IF YOU REQUIRE MORE INFORMATION OR CHANGES TO THE WORDING PLEASE RING.

WORDING IS :-

84141000

PUMPS, ROTARY VACUUM, OIL FREE, HAVING THE FOLLOWING

A) VACUUM RANGE FROM 1" HG TO 29.6" HG.

THANKS + REGARDS

[REDACTED]

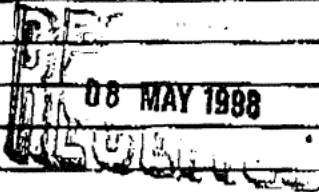

M+D JONES CUSTOMS PTY LTD  
TARIFF CONSULTANT.

**NO OBJECTION!**

[REDACTED]

Dr. ...

Released by Department of Home Affairs under the Freedom of Information Act 1982



18/24



**M. & D. JONES CUSTOMS PTY. LTD.**  
CUSTOMS & FORWARDING BROKERS  
**TOMAX CONTAINER LINE AUSTRALIA PTY LTD.**

ACN 008 753 439

ACN 007 181 191



1ST FLOOR, 559 QUEENSBERRY STREET  
NORTH MELBOURNE, VICTORIA 3051  
PO BOX 141, NORTH MELBOURNE VIC. 3051

TELEPHONE: (03) 9329 5399

FAX: (03) 9328 4866

FAXING 1/2

No. OF PAGES INCLUDING THIS ONE: **TWO (2) PAGES**

ATTENTION S47F	COMPANY / LOCATION DYNAVAC	FAX No. 98003371	
SENDER S47F	BUSINESS UNIT / LOCATION TARIFF CONSULTANT M + D JONES CUSTOMS P/L	DATE 8/5/98	TIME

WE ARE FAXING YOUR COMPANY TO INFORM YOU OF OUR INTENTIONS TO LODGE THE BELOW WORDED CONCESSION APPLICATION

PLEASE NOTE I HAVE INCLUDED AN INFORMATION SHEET FOR YOUR PERUSAL.

PLEASE EITHER REPLY BY FAX / LETTER YOUR ACCEPTANCE AND NO OBJECTION TO THIS APPLICATION, OR IF YOU REQUIRE MORE INFORMATION OR CHANGES TO THE WORDING PLEASE RING.

WORDING IS :-

84141000

PUMPS, ROTARY VACUUM, OIL FREE, HAVING THE FOLLOWING

A) VACUUM RANGE FROM 1" HG TO 29.6" HG.

THANKS + REGARDS

S47F

M + D JONES CUSTOMS PTY LTD  
TARIFF CONSULTANT.

Released by Department of Home Affairs under the Freedom of Information Act 1982

19/24/00



**M. & D. JONES CUSTOMS PTY. LTD.**  
CUSTOMS & FORWARDING BROKERS  
ACN 006 753 433  
**TOMAX CONTAINER LINE AUSTRALIA PTY LTD.**  
ACN 007 121 191



1ST FLOOR, 559 QUEENSBERRY STREET  
NORTH MELBOURNE, VICTORIA 3051  
PO BOX 141, NORTH MELBOURNE VIC. 3051

TELEPHONE: (03) 9329 5399

FAX: (03) 9328 4666

FAXED +1/2

No. OF PAGES INCLUDING THIS ONE: Two (2) PAGES

ATTENTION S47F	COMPANY / LOCATION R.G. SWADESIR	FAX No. 93861254	
SENDER S47F	BUSINESS UNIT / LOCATION TARIFF CONSULTANT M + D JONES CUSTOMS P/L	DATE 8/5/98	TIME

WE ARE FAXING YOUR COMPANY TO INFORM YOU OF OUR INTENTIONS TO LODGE THE BELOW WORDED CONCESSION APPLICATION

PLEASE NOTE I HAVE INCLUDED AN INFORMATION SHEET FOR YOUR PERUSAL.

PLEASE EITHER REPLY BY FAX / LETTER YOUR ACCEPTANCE, AND NO OBJECTION TO THIS APPLICATION, OR IF YOU REQUIRE MORE INFORMATION OR CHANGES TO THE WORDING PLEASE RING.

WORDING IS :-

84141000

PUMPS, ROTARY VACUUM, OIL FREE, HAVING THE FOLLOWING

A) VACUUM RANGE FROM 1" HG TO 29.6" HG.

THANKS + REGARDS

S47F

M + D JONES CUSTOMS PTY LTD  
TARIFF CONSULTANT.

Released by Department of Home Affairs  
under the Freedom of Information Act 1982

9



**M. & D. JONES CUSTOMS PTY. LTD.**  
CUSTOMS & FORWARDING BROKERS  
**TOMAX CONTAINER LINE AUSTRALIA PTY LTD.**

ACN 008 753 438

ACN/007 121 191

1ST FLOOR, 559 QUEENSBERRY STREET  
NORTH MELBOURNE, VICTORIA 3051  
PO BOX 141, NORTH MELBOURNE VIC. 3051

TELEPHONE: (03) 9329 5399

FAX: (03) 9328 4666

20/24  
**TCL**

*[Handwritten signature]*  
H2

No. OF PAGES INCLUDING THIS ONE:

TWO (2) PAGES

S47F ATTENTION [Redacted]	COMPANY / LOCATION O'HAIR ENGINEERING / PUMPS DISTRIBUTORS	FAX No. 07 38681178	
S47F SENDER [Redacted]	BUSINESS UNIT / LOCATION TARIFF CONSULTANT M + D JONES CUSTOMS P/L	DATE 8/5/98	TIME

WE ARE FAXING YOUR COMPANY TO INFORM YOU OF OUR INTENTIONS TO LODGE THE BELOW WORDED CONCESSION APPLICATION

PLEASE NOTE I HAVE INCLUDED AN INFORMATION SHEET FOR YOUR PERUSAL.

PLEASE EITHER REPLY BY FAX / LETTER YOUR ACCEPTANCE AND NO OBJECTION TO THIS APPLICATION, OR IF YOU REQUIRE MORE INFORMATION OR CHANGES TO THE WORDING PLEASE RING.

WORDING IS :-

84141000

PUMPS, ROTARY VACUUM, OIL FREE, HAVING THE FOLLOWING

A) VACUUM RANGE FROM 1" HG TO 29.6" HG.

THANKS + REGARDS

S47F

[Redacted signature]

M + D JONES CUSTOMS PTY LTD

TARIFF CONSULTANT.

Released by Department of Home Affairs  
under the Freedom of Information Act 1982

8

# Motor Mounted Rotary Vane .6, 1.1, and 1.5 cfm



## Oiless 0531, 1031, 1531 Series

21/24

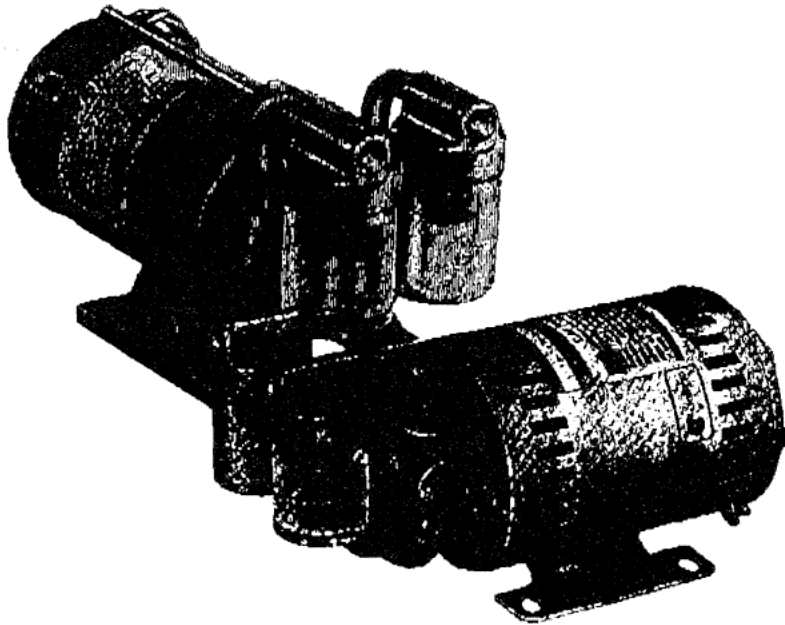

**MODEL 0531 SERIES**  
20" MAX. VAC., .60 CFM OPEN FLOW

**MODEL 1031 SERIES**  
20" MAX. VAC., 1.10 CFM OPEN FLOW

**MODEL 1531 SERIES**  
20" MAX. VAC., 1.50 CFM OPEN FLOW

### PRODUCT FEATURES

- Oilless operation
- Motor mounted
- Rugged construction/low maintenance
- Essentially pulse-free service

### INCLUDES (ALL MODELS)

- Muffler
- Filter
- Thermotector (on AC models only)

### RECOMMENDED ACCESSORIES

- Vacuum relief valve AA204
- Vacuum gauge AA641
- Repair kit K269 (0531), K219 (1031), K219 (1531)

### COMMON MOTOR OPTIONS AVAILABLE

- 115V, 60/50 Hz, single phase
- 230V, 60/50 Hz, single phase
- 12V DC
- 24V BLDC

Various brand name motors are used on any model at the discretion of Gast Mfg. Corp.

### Important Notice:

Pictorial and dimensional data is subject to change without notice.

### Product Dimensions Metric (mm) U.S. Imperial (Inches)

Model	A	B	C	D	E	F	G	H	I	J	K	L
0531	62	223	76	33	89	67	22	103	111	-	-	-
0531	2.44	8.78	3.00	1.28	3.50	2.62	.88	4.08	4.37	-	-	-
1031	62	229	76	33	89	67	22	116	124	-	-	-
1031	2.44	9.00	3.00	1.28	3.50	2.62	.88	4.57	4.88	-	-	-
1531	62	228	72	39	-	44	-	113	121	86	108	58
1531	2.44	8.97	2.82	1.53	-	1.75	-	4.45	4.76	3.38	4.19	2.07

Dimensions for reference only.

Models 0531, 1031

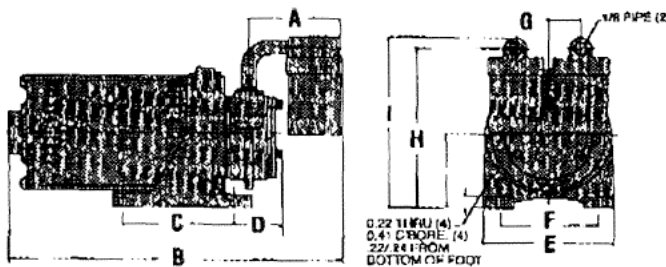

Model 1531

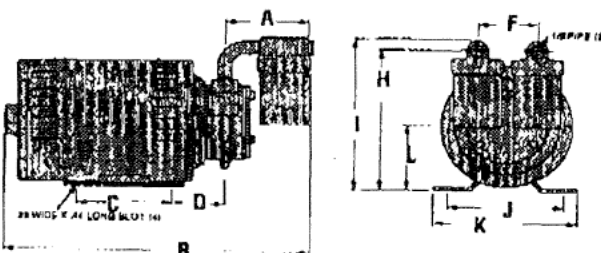

Released by Department of Home Affairs under the Freedom of Information Act 1982

# Separate Drive Rotary Vane <sup>8.5, 17.0</sup> and 21.0 cfm



## Oilless 1067, 2067, 2567 Series

22/24

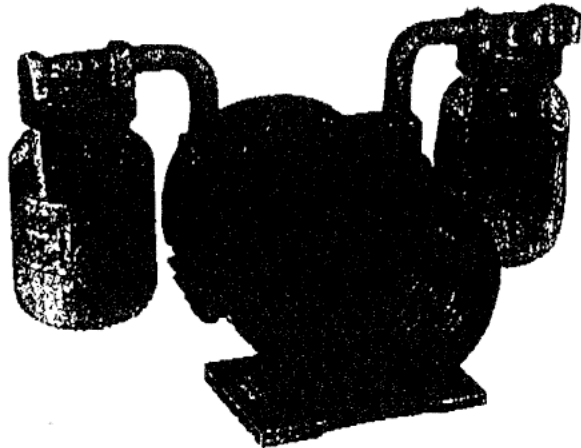

### MODEL 1067 SERIES

28" HG MAX. VAC., 8.50 CFM OPEN FLOW

### MODEL 2067 SERIES

27" HG MAX. VAC., 17.00 CFM OPEN FLOW

### MODEL 2567 SERIES

27" HG MAX. VAC., 21.00 CFM OPEN FLOW

### PRODUCT FEATURES

- Oilless operation
- Close coupled/easy motor mounting
- Rugged construction/low maintenance
- Essentially pulse free service

### EUROPEAN MODEL

#### Product Dimensions Metric (mm)

Model	A	B	C	D	E	F	G	H	I	J	K	L
1067	429	213	240	254	102	11	125	165	241	142	19	80
2067	448	229	315	333	102	11	124	185	284	164	19	80
2567	449	229	315	333	102	11	125	185	284	164	19	80

### INCLUDES

- Filter AAB00C (1067), AA900D (2067/2567)
- Muffler AAB00F (1067), AA800F (2067/2567)
- Fan/coupling assembly AH198
- Fan guards AC102C, AH194

### RECOMMENDED ACCESSORIES

- Vacuum relief valve AA840A (1067), AA308 (2067/2567)
- Vacuum relief valve AA308B (2067/2567)
- Vacuum gauge AA840
- Vacuum gauge AA640C
- Repair kit K356 (1067)
- Repair kit K350 (2067/2567)

### U.S. MODEL

#### Product Dimensions Metric (mm) U.S. Imperial (Inches)

Model	A	B	C	D	E	F	G	H	I	J	K	L	M	N	O
1067	429	213	240	254	102	11	124	165	454	-	-	142	241	76	21
1067	16.88	8.40	9.44	10.0	4.0	.44	4.88	6.5	17.88	-	-	5.59	9.50	3.00	.84
2067	449	229	315	333	102	11	124	185	540	58	18	164	284	.76	21
2067	17.69	9.0	12.42	13.12	4.0	.44	4.88	6.5	21.25	2.19	.69	6.44	11.19	3.00	.84
2567	449	229	315	333	102	11	124	185	540	56	18	164	284	76	21
2567	17.89	9.0	12.42	13.12	4.0	.44	4.88	6.5	21.25	2.19	.69	6.44	11.19	3.00	.84

Dimensions for reference only.

### Important Notice:

Pictorial and dimensional data is subject to change without notice.

### METRIC MODEL

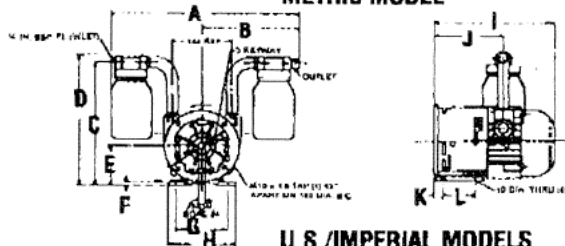

INLET  
2067/2567 3/4 IN. BSP.  
1067 1/2 IN. BSP.

### U.S./IMPERIAL MODELS NEMA 56 FRAME, C FACE

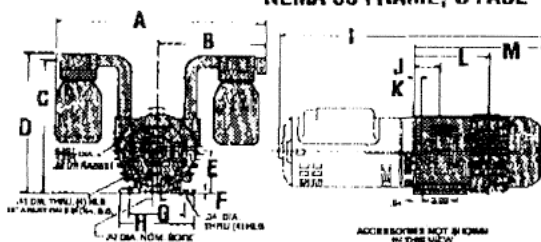

INLET  
2067/2567 3/4 NPT  
1067 1/2 NPT

Released by Department of Home Affairs under the Freedom of Information Act 1982

23/24

6

# Oilless Rocking Piston 2.6, 4.5 and 5.5 cfm

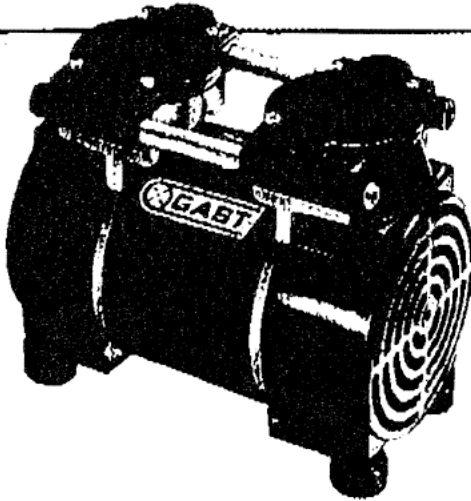

## 71R/72R Series Twin Cylinder

VACUUM

**MODELS 71R645/71R655**  
28" HG MAX. VACUUM, 4.5 CFM OPEN FLOW

**MODELS 72R547/72R555**  
29" HG MAX. VACUUM, 2.6 CFM OPEN FLOW

**MODELS 72R645/72R655**  
28" HG MAX. VACUUM, 5.5 CFM OPEN FLOW

### Product Dimensions Metric (mm) U.S. Imperial (Inches)

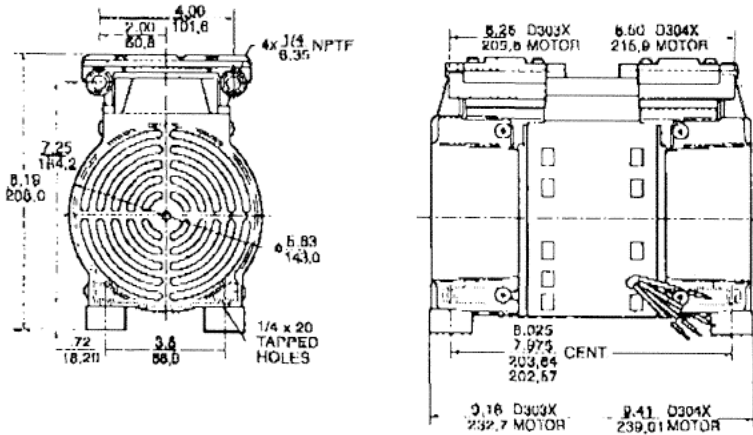

### PRODUCT FEATURES

- Oilless operation
- All wetted aluminum parts treated for corrosion protection from moisture
- Rugged motor shell construction

### INCLUDES

- Dry-cell capacitor AT250 (D303X Motor), AT251 (D304X Motor) - not pictured, shipped unattached
- Rubber feet (4) AB319

### COMMON MOTOR OPTIONS

- 115V, 60 Hz, single phase
- 220-240V, 50 Hz, single phase

### RECOMMENDED ACCESSORIES

- Relief valve AAB40A
- Vacuum gauge AA640

### Product Specifications

Model Number	Motor	Type	RPM		HP	kw	Net Wt.	
			60 Cycle	50 Cycle			lbs.	kg
71R645-V114-D303X	115-60-1	PSC (4 Pole)	1650	---	1/3	0.25	15.6	7.09
71R655-V114-D304X	220-240-50-1	PSC (4 Pole)	---	1425	1/3	0.25	18.0	7.27
72R547-V116-D303X	115-60-1	PSC (4 Pole)	1650	---	1/3	0.25	15.6	7.09
72R555-V116B-D304X	220-240-50-1	PSC (4 Pole)	---	1425	1/3	0.25	16.0	7.27
72R645-V114-D303X	115-60-1	PSC (4 Pole)	1650	---	1/3	0.25	15.6	7.09
72R655-V116-D304X	220-240-50-1	PSC (4 Pole)	---	1425	1/3	0.25	18.0	7.27

### Product Performance (Metric, U.S. Imperial)

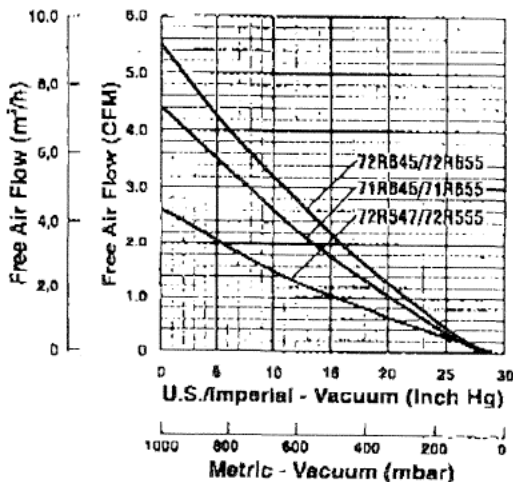

Released by Department of Justice under the Freedom of Information Act 1982

# Diaphragm to 1.8 cfm



## DOA Series

24/24

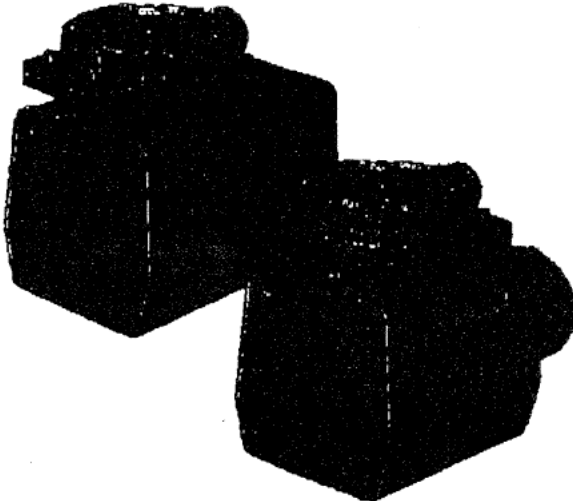

**SHADED POLE VERSION**  
25.5" HG MAX. VAC., 1.1 CFM OPEN FLOW

**4-POLE PSC VERSION**  
25.5" HG MAX. VAC., 1.1 CFM OPEN FLOW

**2-POLE PSC VERSION**  
25.5" HG MAX. VAC., 1.8 CFM OPEN FLOW

**LOW SPEED DC VERSION**  
25.5" HG MAX. VAC., 1.3 CFM OPEN FLOW

**HIGH SPEED DC VERSION**  
25.5" HG MAX. VAC., 1.8 CFM OPEN FLOW

### PRODUCT FEATURES

- Oilless operation
- Motor mounted
- Rugged construction/low maintenance

### INCLUDES

- Muffler AH190A
- Capacitor AFB73A ('DB' and 'DD' motor), AF485 ('FB' motor), AFB76 ('FD' motor)

### COMMON MOTOR OPTIONS

- 12V DC
- 24V DC
- 115V, 60 Hz, single phase
- 110V, 60 Hz, single phase
- 230V, 60 Hz, single phase
- 220/240V, 50 Hz, single phase
- 100V, 50/60 Hz, single phase
- 115/110V, 60/50 Hz, single phase
- 230/220V, 60/50 Hz, single phase

### RECOMMENDED ACCESSORIES

- Vacuum gauge AA640
- Vacuum relief valve AA550C-V
- (4) Rubber feet AF584A
- Repair kit K294A

Consult factory for replacement brushes for DC motors.

Various brand name motors are used on any model at the discretion of GAST Mfg. Corp.

### Important Notice:

Pictorial and dimensional data is subject to change without notice.

### Product Dimensions Metric (mm) U.S. Imperial (Inches)

Model	A	B	C	D	E	F	G	H
DOA AC	193	171	44	89	130	22	121	194
DOA AC	7.59	6.75	1.75	3.50	5.12	.88	4.75	7.82
DOA DC	193	171	44	89	130	22	121	237
DOA DC	7.59	6.75	1.75	3.50	5.12	.88	4.75	9.12

Dimensions for reference only.

### PSC/Shaded Pole Models

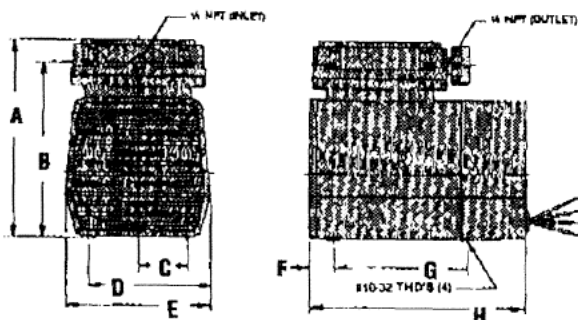

### DC Models

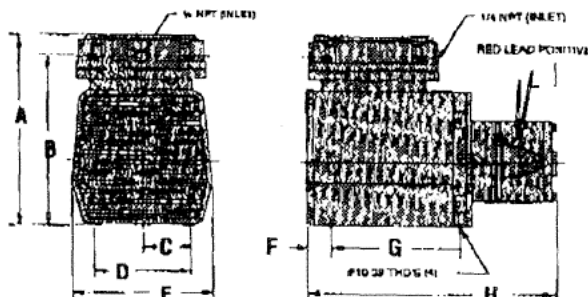

Released by Department of Home Affairs under the Freedom of Information Act 1982



**M. & D. JONES CUSTOMS PTY. LTD.**  
 CUSTOMS & FORWARDING BROKERS ACN 006 763 439  
**TOMAX CONTAINER LINE AUSTRALIA PTY LTD.**  
 ACN 007 121 191



1ST FLOOR, 559 QUEENSBERRY STREET  
 NORTH MELBOURNE, VICTORIA 3051  
 PO BOX 141, NORTH MELBOURNE VIC. 3051

TELEPHONE: (03) 9329 5399

FAX: (03) 9328 4666

1/24

No. OF PAGES INCLUDING THIS ONE: TWENTY-FOUR (24) PAGES

ATTENTION <b>LODGE MENT SECTION</b> <b>TARIFF CONCESSIONS</b>	COMPANY / LOCATION <b>ACS - CANBERRA</b>	FAX No. <b>026 275 6376</b>	
SENDER <small>S47F</small>	BUSINESS UNIT / LOCATION <b>CUSTOMS BROKER</b>	DATE <b>21/5/98</b>	TIME

PLEASE FIND OUR NEW APPLICATION

ENCLOSED

THANKS + REGARDS

S47F  
 [Redacted signature area]

98 MAY 21 10:12 AM BP

Released by Department of Home Affairs  
 under the Freedom of Information Act 1982





25

Reply to the Chief Executive Officer

Quote: TC 9804360

Customs House  
5 Constitution Avenue  
Canberra ACT 2601  
email: information@customs.gov.au  
Ph. 02 s22(1)(a)(ii)  
Fax. 02 62758578

Your Ref:MDJ/NOR-VAC

22 MAY 98

Dear Sir/Madam,

APPLICATION FOR A TARIFF CONCESSION ORDER

Your application for a Tariff Concession Order, details of which are shown below, was received in this office on 21 MAY 98. The TC number shown above has been allocated to your application.

Date Sent : 21 MAY 98  
Applicant : IMI NORGRN PTY LTD  
Goods : ROTARY VACUUM PUMPS  
Owner Code : 0905410A

If you have not been using the above Owner Code for this company would you please do so for future applications.

Yours faithfully,

s22(1)(a)(ii)  
for National Manager  
Industry

TC (B2)  
see F3 for  
wording

M & D JONES CUSTOMS PTY LTD  
Attn: s47F

PO BOX 141  
NORTH MELBOURNE VIC 3051

s22(1)(a)(ii)

Released by Department of Home Affairs  
under the Freedom of Information Act 1982

## THE TABLE

	COLUMN 1 Description of Goods including the Customs Tariff Classification	COLUMN 2 Prescribed Item No. Date
8414.10.00	PUMPS, ROTARY VACUUM, oil free, having ALL of the following: (a) vacuum range from 33 mbar (1" Hg) to 982 mbar (29.6" Hg); (b) motor driven Op. 21.05.98 STATED USE: Vacuum pumps for air and gas  Applicant: IMI NORGREN PTY LTD KNOXFIELD, VIC, 3178	50          - TC 9804360

Released by Department of Home Affairs  
under the Freedom of Information Act 1982



**M. & D. JONES CUSTOMS PTY. LTD.**  
CUSTOMS & FORWARDING BROKERS  
**TOMAX CONTAINER LINE AUSTRALIA PTY LTD.**



1ST FLOOR, 559 QUEENSBERRY STREET  
NORTH MELBOURNE, VICTORIA 3051  
PO BOX 141, NORTH MELBOURNE VIC. 3051

TELEPHONE: (03) 9329 5399

FAX: (03) 9328 4666

'98 MAY 27 14:26

No. OF PAGES INCLUDING THIS ONE:

<p>ATTENTION</p> <p>s22(1)(a)(ii)</p>	<p>COMPANY / LOCATION</p> <p>ACS - CANBERRA TARIFF CONCESSIONS</p>	<p>FAX No.</p> <p>026275 6376</p>	
<p>BENDER</p> <p>s47F</p>	<p>BUSINESS UNIT / LOCATION</p> <p>CUSTOMS BROKER FOR NORGREN</p>	<p>DATE</p> <p>27/5/98</p>	<p>TIME</p>

RE OUR APPLICATION NO. 9804360

CAN YOU PLEASE AMEND THE WORDING TO  
READ AS FOLLOWS:—

PUMPS, ROTARY VACUUM, OIL FREE, HAVING ALL OF THE  
FOLLOWING:

- A) VACUUM RANGE FROM 33MBAR (1" HG) TO 982 MBAR (29.6" HG).
- B) MOTOR DRIVEN

THANKS + REGARDS

s47F

Done, see folio 26

s22(1)(a)(ii)

27/5/98

G09/17:95/REV.0

Released by Department of Home Affairs  
under the Freedom of Information Act 1982

**MINUTE PAPER**  
CENTRAL OFFICE

28

TR(C1)

Please provide a Tariff Classification for the goods subject of this Tariff Concession application

**NAME:** s22(1)(a)(ii) **TC(B3)**

**DATE:** 250598

**DATE REC'D (in TCs):** 210598

**APPLICANT:** IMI Norgren pty ltd

**GOODS:** Pumps, rotary vacuum

**CLAIMED CLASSIFICATION** 84141000

**TA No & CLASS'N:** \_\_\_\_\_

**INSUFFICIENT INFO. (REASONS):** \_\_\_\_\_

**PRECEDENT No & CLASS'N:** \_\_\_\_\_

**TARIFF ADVICE No (TAPIN):** \_\_\_\_\_

**DECISION:** 8414.10.00

**COMMENTS:** \_\_\_\_\_

**RETURNED** s22(1)(a)(ii)

**NAME:** \_\_\_\_\_

**DATE:** 29/5/98

Released by Department of Home Affairs  
under the Freedom of Information Act 1982



# AUSTRALIAN CUSTOMS SERVICE

Reply to the Chief Executive Officer

Quote: TC 9804360

Your Ref: MDJ/NOR-VAC

Customs House  
5 Constitution Avenue  
Canberra ACT 2601

email: information@customs.gov.au

Ph. 02 s22(1)(a)(ii)

Fax. 02 62756376

01 JUN 98

Dear Sir/Madam,

## TARIFF CONCESSION - APPLICATION ACCEPTANCE

Your application for a Tariff Concession Order (TCO) has been accepted by Customs as a valid application. The application will be published in Gazette No. TC 98/23 of 10 JUN 98. Details of the gazette notice are shown in the attachment.

Please examine the wording of the gazette notice and advise this office immediately if the wording does not accurately describe the goods for which a TCO has been sought. This is a verification of agreed wording, not an opportunity to further amend.

Yours faithfully,

s22(1)(a)(ii)

Delegate of the Chief Executive Officer

M & D JONES CUSTOMS PTY LTD  
Attn: s47F

PO BOX 141  
NORTH MELBOURNE VIC 3051





## SCHEDULE OF CONCESSIONAL INSTRUMENTS

## PART I - TARIFF CONCESSION ORDERS

Description of the particular goods including the applicable subheading of the Customs Tariff	Prescribed Item Last day of effect
8414.10.00 PUMPS, ROTARY VACUUM, oil free, having ALL of the following: (a) vacuum range from 33 mbar (1" Hg) to 982 mbar (29.6" Hg); (b) motor driven Op. 21.05.98 - TC 9804360	50

Released by Department of Home Affairs  
under the Freedom of Information Act 1982





# AUSTRALIAN CUSTOMS SERVICE

Reply to the Chief Executive Officer

Quote: TC 9804360

Customs House  
5 Constitution Avenue  
Canberra ACT 2601

email: information@s22(1)(a)(ii)  
Ph. [REDACTED]

Your Ref:MDJ/NOR-VAC

31 JUL 98

Dear Sir/Madam,

## TARIFF CONCESSION SYSTEM - APPLICATION SUCCESSFUL

I refer to your application for a Tariff Concession Order (TCO) lodged on 21 MAY 98.

As a delegate of the Chief Executive Officer, I am satisfied that the application meets the core criteria on the basis of paragraph 269C of the Customs Act 1901 and have accordingly made a written Tariff Concession Order.

The decision to make a TCO will be published in Gazette No. TC 98/32 of 12 AUG 98.

The TCO, as detailed in the attachment, will be published in the Schedule of Concessional Instruments as soon as possible.

Yours faithfully,

s22(1)(a)(ii)

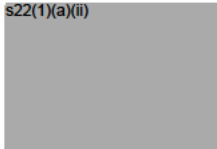

Delegate of the Chief Executive Officer

M & D JONES CUSTOMS PTY LTD  
Attn: s47F [REDACTED]

PO BOX 141  
NORTH MELBOURNE VIC 3051

Released by Department of Home Affairs  
under the Freedom of Information Act 1982

TARIFF CONCESSION REVOCATION ORDER

Under section 269SD(2) of the Customs Act 1901, I s22(1)(a)(ii) a delegate of the Comptroller-General of Customs

(a) revoke Tariff Concession Order Number 9804360 made on 31.07.98, in respect of the goods described in TABLE A below. This Revocation has effect from 01.01.17; and

(b) make in its place the Tariff Concession Orders described in TABLE B. The goods specified in Column 1 of TABLE B are goods to which the item in Part III of Schedule 4 to the Customs Tariff Act 1995 specified in Column 2 of TABLE B applies. The Order shall have effect from the date notified in paragraph (a) above as the date of effect for the Revocation.

TABLE A

COLUMN 1 Description of Goods including the Customs Tariff Classification	COLUMN 2 Schedule 4 Item Number Last date of effect
8414.10.00 PUMPS, ROTARY VACUUM, oil free, having ALL of the following: (a) vacuum range from 33 mbar (1" Hg) to 982 mbar (29.6" Hg); (b) motor driven  Op. 21.05.98	50 31.12.16
- TC 9804360	

Released by Department of Home Affairs  
under the Freedom of Information Act 1982

This is page 1 of 2 Pages of the instrument.

Dated 19 December 2016

s22(1)(a)(ii)  
.....  
Delegate of the Comptroller-General of Customs

TABLE B

Description of Goods including the Customs Tariff Classification	COLUMN 1	COLUMN 2 Schedule 4 Item Number Last date of effect
--	----------	---

8414.10.90	PUMPS, ROTARY VACUUM, oil free, having ALL of the following: (a) vacuum range from 33 mbar (1" Hg) to 982 mbar (29.6" Hg); (b) motor driven	50
------------	---	----

Op. 01.01.17 - TC 1679234

Released by Department of Home Affairs  
under the Freedom of Information Act 1982

This is page 2 of 2 Pages of the instrument.

Dated 19 December 2016

s22(1)(a)(ii)  
 Delegate of the Comptroller-General of Customs